

HDANYWHERE



## MHUB PRO 2.0

**MHUB PRO 2.0 (4x4) 40** CODE: MHUBPRO24440

**MHUB PRO 2.0 (8x8) 100** CODE: MHUBPRO288100

Product Guide (English UK)

**Box. Fe**

1.

eatures. Specs.

# Contents

|   |       |
|---|-------|
| Glossary of terms, In the box                             | 4-5   |
| Features, Specifications                                  | 6-7   |
| Panel description & MHUB PRO 2.0 (4x4) 40 panel diagram   | 10-11 |
| MHUB PRO 2.0 (8x8) 100 panel diagram                      | 12    |
| MHUB PRO 2.0 Display Receiver panel diagram & description | 13    |
| IR (Infrared) control                                     | 14    |
| Using the Master & Room Remote, Testing that IR works     | 15    |
| Cabling   | 16    |
| Hiring a HDA Pro  | 17    |
| MHUB control methods                                      | 18    |
| Stacking: creating V&A systems                            | 19    |
| Example wiring diagram & explanation                      | 22-24 |
| Power up  | 25    |
| Setup on uControl   | 28-29 |
| Accessing MHUB-OS & MHUB-OS settings                      | 32-33 |
| uControl interface  | 36-37 |
| Legals: Compliance, conformity & Product Guarantee        | 40-41 |

# Glossary of terms

|   |   |
|---|---|
| <b>MHUB</b>                               | Video or Audio distribution systems manufactured by HDANYWHERE.   |
| <b>Consumer Electronics Control (CEC)</b> | An optional feature-set within the HDMI specification allowing a single remote control to control multiple devices connected via HDMI.  |
| <b>Tipping Point Compression (TPC)</b>    | Video content such as Ultra HD 4K 60 4:4:4 uses up to 18Gbps of data at any one time which is not possible over current HDBaseT technology. HDA makes transmission of 18Gbps content possible using TPC. Visually lossless, TPC only becomes active if HDBaseT's threshold is breached, hence the term tipping point. |
| <b>Audio Return Channel</b>               | ARC enables audio from a display to be extracted and returned to MHUB.  |
| <b>V&amp;A</b>                            | Term used to describe one Video enabled MHUB and one or more MHUB AUDIO systems.  |
| <b>HDBaseT</b>                            | Technology used to convert HDMI in to a format which can be carried over network cable.   |
| <b>IR RX &amp; IR TX</b>                  | Infrared (IR) Receiver (RX) and Transmitter (TX). The RX 'receives' a signal from another remote control and the TX 'transmits' it.   |
| <b>uControl</b>                           | A remote control app for MHUB systems made by HDANYWHERE and available from iOS & Android app stores.   |
| <b>Control System</b>                     | A 3rd party method of control for MHUB systems. For example, Crestron, Control4, RTI, Savant, Fibaro etc.   |
| <b>MHUB-OS</b>                            | MHUB's on-board operating system from which most settings can be configured.  |



# In the box



Name: **MHUB PRO 2.0 (4x4) 40**  
 Product code: **MHUBPRO24440**

|           |   |
|-----------|---|
| <b>x1</b> | MHUB PRO 2.0 (4x4) 40 Chassis/Hub                   |
| <b>x4</b> | Display receiver                                    |
| <b>x9</b> | Infrared Transmitter cable (1.5m) (IR TX)           |
| <b>x5</b> | Infrared (20-60Khz) Receiver cable (1.5m) (IR RX)   |
| <b>x8</b> | Three Pin Phoenix Connector                         |
| <b>x5</b> | Chassis and display receiver mounting bracket pairs |
| <b>x1</b> | Master remote control                               |
| <b>x1</b> | In-room remote control                              |
| <b>x1</b> | RS232 serial cable (1.5m)                           |
| <b>x1</b> | 100-240V AC 50/60Hz cable (IEC lead)                |
| <b>x1</b> | User Guide  |



Name: **MHUB PRO 2.0 (8x8) 100**  
 Product code: **MHUBPRO288100**

|            |   |
|------------|---|
| <b>x1</b>  | MHUB PRO 2.0 (8x8) 100 Chassis/Hub                  |
| <b>x8</b>  | Display receiver                                    |
| <b>x17</b> | Infrared Transmitter cable (1.5m) (IR TX)           |
| <b>x9</b>  | Infrared (20-60Khz) Receiver cable (1.5m) (IR RX)   |
| <b>x16</b> | Three Pin Phoenix Connector                         |
| <b>x9</b>  | Chassis and display receiver mounting bracket pairs |
| <b>x1</b>  | Master remote control                               |
| <b>x1</b>  | In-room remote control                              |
| <b>x1</b>  | RS232 serial cable (1.5m)                           |
| <b>x1</b>  | 100-240V AC 50/60Hz cable (IEC lead)                |
| <b>x1</b>  | User Guide  |

## IMPORTANT:

For optimum performance and safety, please read these instructions carefully before connecting, operating or configuring this product. Please keep this manual for future reference.

### Surge protection is recommended

This MHUB system contains sensitive electrical components that may be damaged by electrical spikes, surges, electric shock, lightning strikes, etc. The usage of surge protection systems is recommended in order to protect and extend the life of your system.

## Features

Supports video picture formats up to 4K@60Hz (4:4:4)

Multi-channel digital audio support up to and including Dolby/Atmos and DTS:X

Capable of video + audio matrixing with additional audio inputs

Simultaneous multi-channel and downmixed audio output

Auto down scaling on all outputs

Route ARC & HDMI source audio to audio matrix

Bi-directional IR & RS232

10/100 Ethernet available on Display Receiver (MHUBPRO288100 only)

CEC, HDR and advanced EDID management

uControl & Amazon Alexa compatible

Remotely manageable

Includes HDA API 2

Premium touchpanel/aluminium design



# Specification

|                       |  |
|-----------------------|--|
| HDMI version          | HDMI 2.0   |
| HDCP compliance       | HDCP 2.2 & HDCP 1.4  |
| Video bandwidth       | 18Gbps   |
| Video resolution      | Up to 4K@60Hz (4:4:4) with HDR   |
| Colour space          | RGB, YCbCr 4:4:4, YUV 4:4:4, YCbCr 4:2:2/4:2:0   |
| Colour depth          | 8-bit, 10-bit, 12-bit (1080p@60Hz)<br>8-bit (4K@60Hz)  |
| HDR formats           | HDR10, HDR10+, Dolby Vision, HLG   |
| Video & audio IO      | MHUBPRO24440<br><b>Inputs:</b> x4 HDMI, x2 3.5mm Stereo Jack, x1S/PDIF, x1 RCA <b>Outputs:</b> x4 HDBaseT, x4 HDMI (Mirror), x4 3.5mm Stereo Jack, x4 Digital Coax   |
|                       | MHUBPRO288100<br><b>Inputs:</b> x8 HDMI, x2 3.5mm Stereo Jack, x1S/PDIF, x1 Coax <b>Outputs:</b> x8 HDBaseT, x8 HDMI (Mirror), x8 3.5mm Stereo Jack, x8 Digital Coax |
| Transmission distance | MHUBPRO24440<br>1080p 70m / 4K 40m<br><br>MHUBPRO288100<br>1080p 100m / 4K 100m  |
| HDMI audio formats    | PCM 2.0 / 5.1 / 7.1, Dolby Digital / Plus / EX, Dolby True HD, DTS, DTS-EX, DTS-96 / 24, DTS High Res, DTS-HD Master Audio, DSD                                      |
| Coax audio formats    | PCM 2.0, Dolby Digital, DTS  |
| Stereo audio formats  | PCM 2.0 44.1 / 48 / 88.2 / 96 / 176.4 / 192KHz, 16 / 20 / 24bit  |

|                       |   |
|-----------------------|---|
| Infrared              | 20Khz - 60Khz   |
| ESD protection        | ±8kV (Air-gap discharge)<br>±4kV (Contact discharge)                            |
| Power consumption     | MHUBPRO24440 68W (Maximum)<br>MHUBPRO288100 130W (Maximum)                      |
| Power supply          | Chassis:<br>100-240V AC 50/60Hz   |
|                       | Display Receiver:<br>24V PoH (Power over HDBaseT)                               |
| Operating temperature | 0°C - 40°C / 32°F - 104°F   |
| Storage temperature   | -20°C - 60°C / -4°F - 140°F   |
| Relative humidity     | 20 - 90% (Non-condensing)   |
| Housing               | Aluminium Enclosure   |
| Colour                | Grey (Carbonite)  |
| Dimensions (W/D/H) mm | MHUBPRO24440<br>Chassis: 440 x 284 x 45<br>Display Receiver: 162.8 x 90 x 18    |
|                       | MHUBPRO288100<br>Chassis: 440 x 372.5 x 88<br>Display Receiver: 162.8 x 90 x 18 |
| Weight                | MHUBPRO24440<br>Chassis: 2400g<br>Display Receiver: 187g                        |
|                       | MHUBPRO288100<br>Chassis: 4200g<br>Display Receiver: 187g                       |

# 10. Contr



2.

ol. IR. Cabling.

# MHUB PRO 2.0 panel description

1. **Source (IN):** HDMI video input ports indicated by numbers.
2. **Video (OUT):** HDBaseT (RJ45) & HDMI video output ports. The HDMI output mirrors the HDBaseT port and is not switchable independently. 18Gbps video will pass through HDMI (uncompressed) whilst the HDBaseT port will use TPC (compression) simultaneously. The HDBaseT port has two indicator lights. Left light: solid means connection between MHUB and display receiver is good. Flashing means that the connection is poor. Off means that there is no connection detected. Right light: solid means HDCP is detected. Flashing means there is no HDCP. Off means no HDMI signal is detected.
3. **LAN (IN):** Connect to a router to extend 10/100 LAN at display locations (MHUBPRO288100 only).
4. **Audio (IN):** x2 3.5mm Stereo Jack, x1 S/PDIF, x1 Coax
5. **RS232 (IN):** Send serial commands to and from this input to the corresponding display receiver RS232 output. Wired (A/GND/B).
6. **Audio (OUT):** Coax & 3.5mm Stereo Jack audio output mirrored ports. Coax outputs multi-channel audio and the 3.5mm Stereo Jack will down-mix to 2-channel stereo simultaneously.
7. **HUB IR (IN):** Connect an IR RX to enable remote (IR) control of MHUB.
8. **Display IR (IN):** Connect an IR RX to send a remote (IR) control command through MHUB to the corresponding display receivers "IR (OUT)" port.
9. **All IR (IN):** Connect an IR RX to this port to send a remote (IR) control command to all display receiver "IR (OUT)" ports.
10. **Source IR (OUT):** Connect an IR TX to control corresponding HDMI inputs.
11. **AVR IR (OUT):** Connect an IR TX to enable remote (IR) control of an AVR.
12. **CONTROL:** Enables TCP/IP control of MHUB.
13. **RS232:** Enables a PC or control system to control MHUB over serial.
14. **GND:** Earthing point to connect MHUB casing to ground.
15. **Power:** Connect the supplied IEC power lead to provide power to MHUB.

A. **HDANYWHERE logo:** Indicator light. If this light is on and solid then MHUB has power and is on.

B. **MHUB PRO 2.0 logo:** Indicator light. If this light is on and solid then MHUB has power and is on. Pressing and holding this button for 2 seconds will toggle MHUB to go in and out of standby mode.

C. **Source Selector:** Selects a HDMI video input.

D. **Notification screen:** OLED screen displaying basic system data and information.

E. **Output Selector:** Routes source selection to the desired output on MHUB. To perform video routing using the front panel you must first select the output that you want to route video to and then select the source using the Source Selector.

F. **TPC indicator:** Indicator light. Lit if Tipping Point Compression is active on any output.

G. **Menu:** Basic management options for MHUB. Tapping the "Menu" button will cycle through the following options:

- Set EDID

Cycle through a list of EDID options using the up /down arrows. Select the desired profile and press "OK" button. You will now be prompted to select a HDMI input port to commit the change to.

- Set Baud

Advanced option to set a baud rate for RS232/serial communication.

- DHCP status & IP address

Cycle between DHCP and IP address options.

Pressing the menu button at any point will return you back one level in navigation.

H. **Up / Down arrows:** Navigates through options on the notification screen.

I. **OK:** Commit a change or proceed through menus in MHUB.



# MHUB PRO 2.0 (4x4) 40: front & rear panel

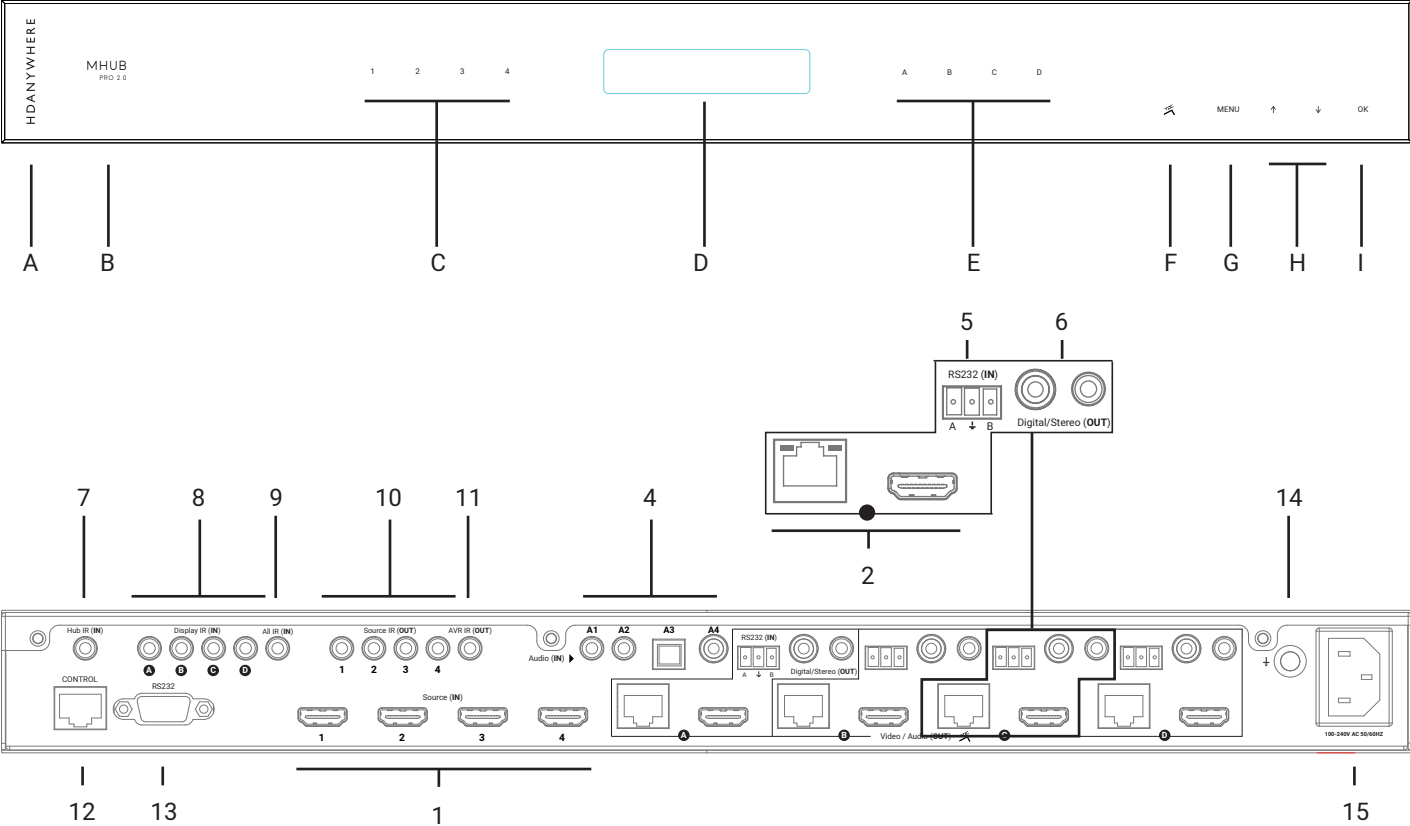

# MHUB PRO 2.0 (8x8) 100: front & rear panel

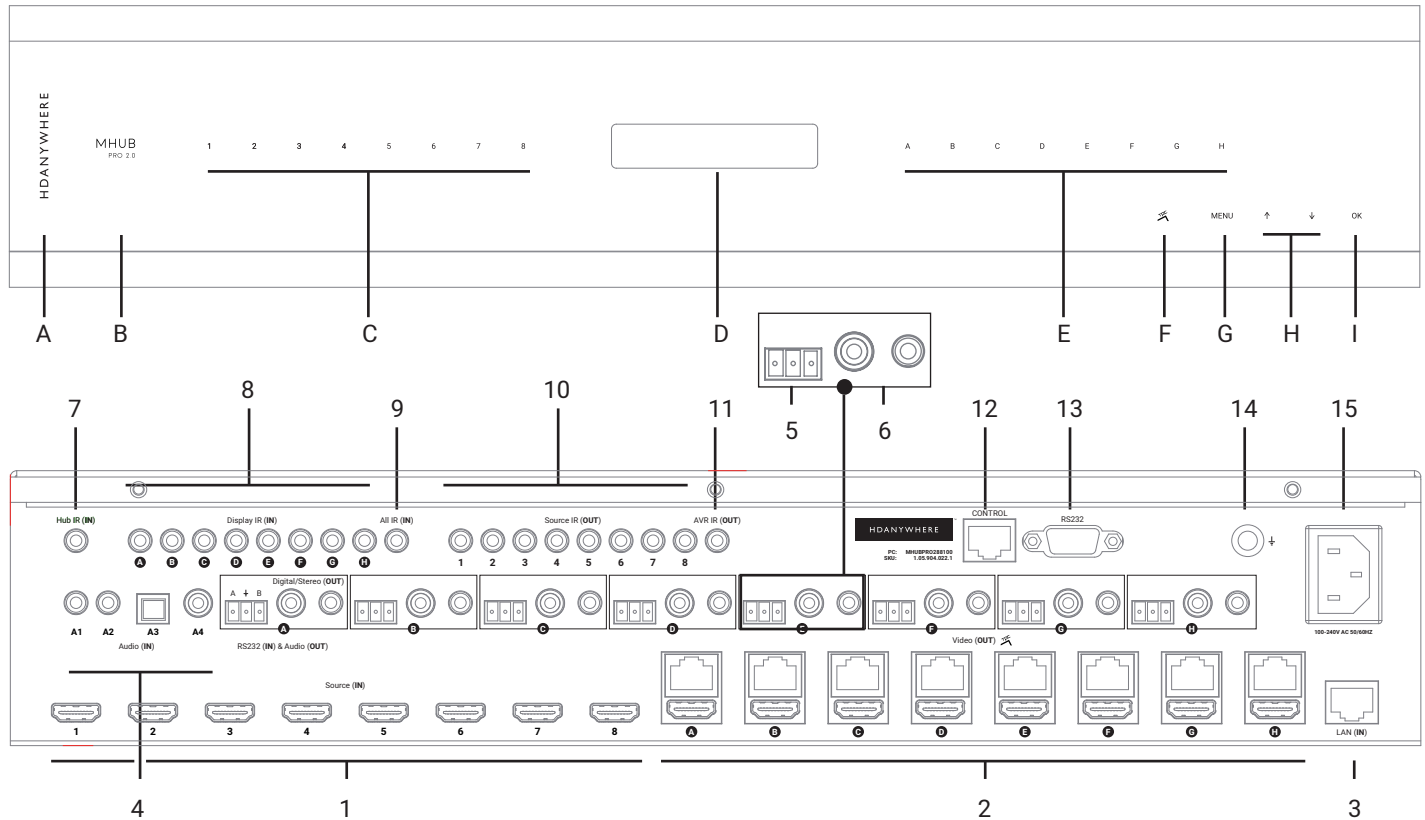

# MHUB PRO 2.0 Display Receiver: front & rear panel

- 1. **Power LED:** Indicator light. If this light is on and solid then the display receiver has power.
- 2. **Firmware Update:** Micro USB port for firmware updates via PC software.
- 3. **Power:** DC24V / 1A. The display receiver is powered via Power over HDBaseT (PoH) from MHUB. The port is there in case of PoH failure.
- 4. **Video:** HDBaseT link between MHUB and display receiver. This port has two indicator lights. Left light: solid means connection between MHUB and display receiver is good. Flashing means that the connection is poor. Off means that there is no connection detected. Right light: solid means HDCP is detected. Flashing means there is no HDCP. Off means there is no HDMI signal at all.
- 5. **IR IN:** Connect an IR RX to send a remote (IR) control command from the display receiver to MHUB's active "Source IR (OUT)" port.
- 6. **IR OUT:** Connect an IR TX to this port to control displays using remote (IR) control commands.
- 7. **HDMI (OUT):** Connect a HDMI cable from the display receiver to your display to provide a picture.
- 8. **RS232 (OUT):** Will output a serial command from MHUB's RS232 (IN) port to a display. Communication is bi-directional. Wired (B/GND/A).
- 9. **LAN:** Connect to any networked device to provide 10/100 LAN access. (MHUBPRO288100 only).

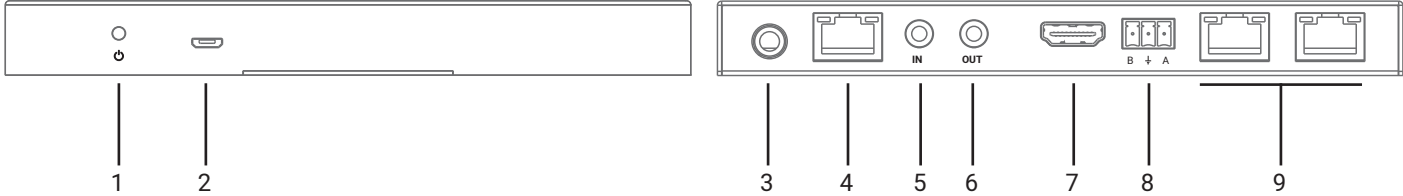

## IR (Infrared) control

MHUB can manage IR signals and route them to sources, AVRs or displays. Using this feature will allow you to use a remote control and pass that IR command from your display location to MHUB or vice-versa.

### Sending IR commands from a display 'back' to MHUB

This will enable backwards IR control (the most common form of IR control) where IR signals from a remote in any one of your zones is sent back to MHUB and your source device.

1. Connect an IR TX to port labelled "Source IR (OUT)" on MHUB. Ensure that the port number matches the port number of the corresponding video source input, labelled "Source (IN)". For example, if you have AppleTV plugged in to port 3, then the IR TX cable should also be connected to Source IR (OUT) port 3.
2. Place the IR TX bud (small tear drop part) in front of the IR window of the source. Repeat for each source device you wish to control.
3. Connect an IR RX to port labelled "IR IN" on the display receiver.
4. Place IR RX head in line-of-sight of the remote control.

### Sending IR commands to a display

1. Connect an IR TX to port labelled "IR OUT" on the display receiver.
2. Place the IR TX bud (small tear drop part) in front of the IR window of the display. Repeat for each display you wish to control.
3. Connect an IR RX to port labelled "Display IR (IN)" on MHUB. Ensure that the port letter matches the port letter routed to the display receiver.
4. Place IR RX head in line-of-sight of the remote control.

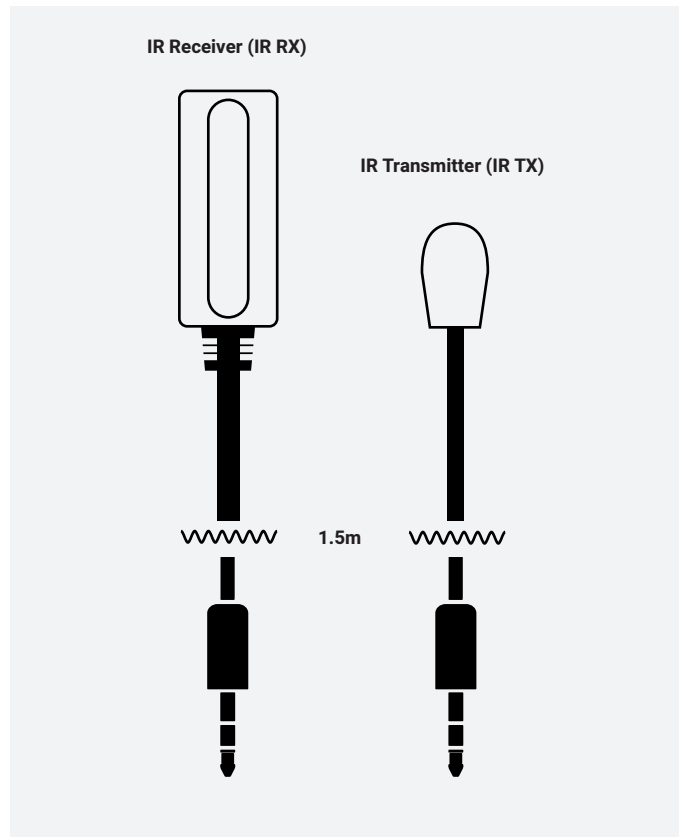

# Using the Master & Room remote

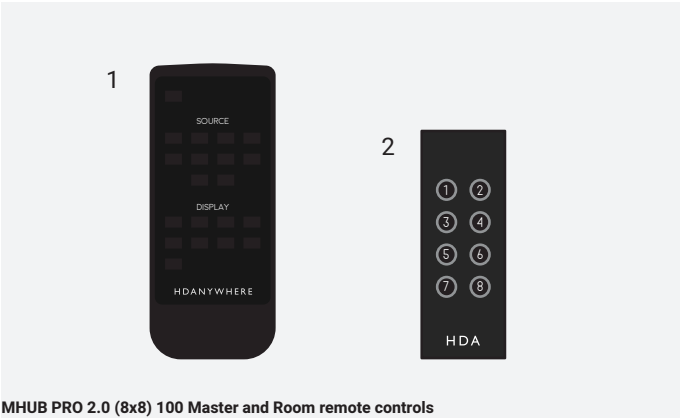

**MHUB PRO 2.0 (8x8) 100 Master and Room remote controls**

MHUB comes with two types of native remote control.

- 1. A Master Remote control
- 2. A Room Remote control

Both remote controls are limited to video switching operations only. HDANYWHERE does not recommend that these remote controls are used as a primary controlling device for MHUB (see section: "MHUB control methods").

The Master Remote control provides video switching control regardless of the room or zone that the command comes from. This is useful if MHUB is installed in an environment like a bar where you might want to switch all TVs from one source to another.

The Room Remote control uses 'contextual' IR which means that it will only switch video sources for the zone or room that you're in.

# Testing that IR control works

This section aims to verify that your MHUB's IR control system is setup correctly and assumes that your MHUB has been wired as per the instructions laid out in this manual. Please refer to the MHUB wiring diagrams in this document to ensure that your setup matches that before proceeding with the verification below.

### Testing basic operation from a display 'back' to MHUB

To verify that IR control is working correctly proceed to any display receiver location with an IR RX connected to it. Use the MHUB Room Remote to select a source with an IR TX connected to it at the MHUB end. You should notice that the MHUB switches to that source on your display. Now pick up your source remote control for the source you just switched to and attempt to control the source using the native remote control. If both work then you have setup IR control correctly. Repeat this step for all display receiver locations.

### Testing commands from MHUB to a display

To verify that control commands from MHUB to your display are working you will need to use uControl, or test using the following method. 1) select a display that you wish to test 2) connect an IR RX to the corresponding Display IR (IN) input 3) ensure that the display receiver has an IR TX connected and that it is pointed to the display IR receiving window 4) take the display remote control to the MHUB location and point the remote at the IR RX, test the on/off command. The display should turn on or off. This will confirm that IR can pass from MHUB to your display successfully.

### Working with identical source devices (discrete IR)

MHUB can work with multiple source devices that are identical due to its discrete IR function. Discrete IR avoids IR clashes that result in unwanted operation of all identical devices. MHUB manages this by targeting IR commands specifically to the source device being watched on the display. When using two or more identical source devices, take measures to avoid IR transmission leaks that could cause the identical source devices to respond in error. This includes simple measures like placing identical sources on different shelves or attempting to 'hood' the IR TX so that IR signals can not leak.

# Cabling

Currently you can use Cat6, Cat6e, Cat6a, Cat7 or Cat7a with MHUB PRO 2.0. Cat5e may work, but is not recommended, due to bandwidth requirements required by the system.

**Note:**  
DO NOT USE ANY COPPER CLAD ALUMINIUM (CCA) Cat 6/7 CABLE.

## Optimum performance

Whichever network cable type you choose, ensure that the main wiring architecture is 'solid core' and not stranded 'patch' cabling. Patch cabling can be used for the last few metres of a run (e.g wallplate) but should be avoided over longer runs as signal transfer over stranded cores is significantly impacted. The use of pre-made leads is not recommended unless you can be absolutely sure of their construction credentials (i.e. solid core 568B). For optimum performance, use a single piece of Cat cable terminated directly at the transmitter and the receiver ends. Make sure to use the correct connector types (i.e. RJ45 solid core) crimp connectors.

## Shielded cables

Shielded FTP cable is not a stipulation. However, if you are using this type of cable ensure compatible shielded accessories are used. Failure to terminate cable screen at all points can induce interference rather than eliminate it.

## Patch panels and wall plates

If patch panels are terminated correctly then there is a minimal loss of distance. The use of wallplates and patch panels has the potential to cause increased resistance on the cable introducing pinch points for signal transmission and could reduce transmission lengths. TIP: Instead of using RJ45 wallplates search for "brush plates" this will yield many results.

## HDMI cabling

HDANYWHERE recommends using suitably robust and good quality HDMI cables. It is not advised to use passive HDMI cables over 5 metres in length either on the inputs or the outputs of MHUB or its display receivers. Where HDMI cables longer than 5 metres are required, HDA recommends utilising its own brand of long distance HDMI cables or suitable alternative.

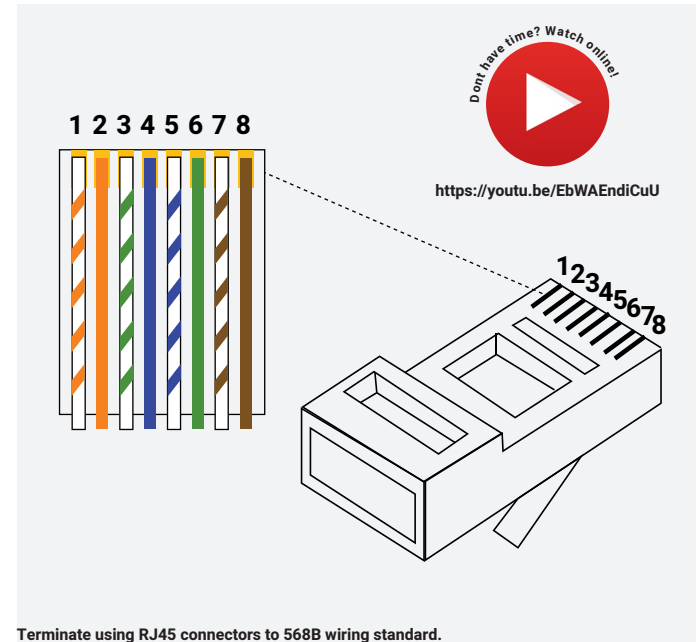

Terminate using RJ45 connectors to 568B wiring standard.



Help is only an email away: [support@hdanywhere.com](mailto:support@hdanywhere.com).



# Hire a HDA Pro

If cabling infrastructure, control and best practises appear a little too much to absorb and learn then why not hire a HDA Pro to do the work instead for you?

Having your MHUB system professionally installed should help to guarantee the system's long-term performance and ensure that it blends neatly with your decor.

All HDA Pros have the added ability to manage your system remotely for you - meaning that routine maintenance and even advanced troubleshooting can be done without the need to visit your home. Ask our HDA Pros for home control, cinema, heating/AC, lighting and security services. Download a guide to picking a HDA Pro here: [https://content2.hdanywhere.com/en/downloads/documents/hdanywhere\\_doc-picking-an-installer.pdf](https://content2.hdanywhere.com/en/downloads/documents/hdanywhere_doc-picking-an-installer.pdf)

**Find a HDA Pro anywhere in the world today**

Visit: <https://hdanywhere.com/dealers-and-installers/>

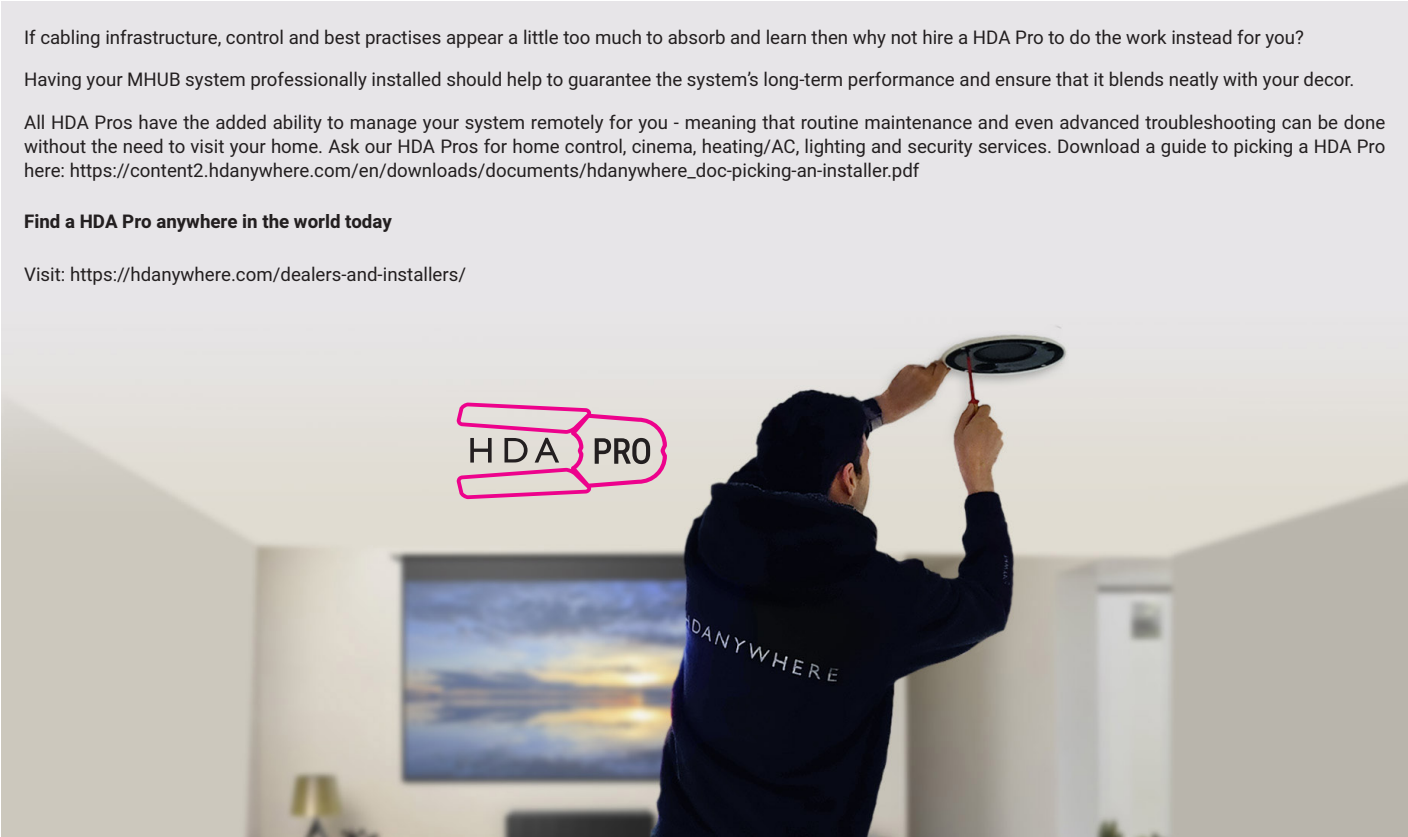

# MHUB control methods

MHUB PRO 2.0 has been designed to be operated and controlled in numerous ways depending on your requirements. There are limited control options from the front panel and from the Master and Room remote, so attention needs to be paid to the method by which MHUB will be controlled. The methods to control and considerations for each are listed below.

## **uControl**

Available for free on iOS and Android, uControl is MHUB's native method of control. All of MHUB's built-in features are available; offering comprehensive control over switching, source/display control, ARC access, executing Sequences and mute states in all zones. uControl communicates over the same Local Area Network (LAN) as your MHUB which allows for global control over the entire system regardless of what zone you are in. In the absence of a third-party control system, HDANYWHERE recommends uControl as the method to control your MHUB on a daily basis.

## **Voice**

All MHUB systems support voice control as standard via an Amazon Echo (Alexa) device. Voice control is not designed to act as a primary control method but to assist the other methods listed on this page. Using voice it is possible to change channels, execute sequences, turn MHUB on/off, increase or decrease display volume and basic transport commands such as play/pause/forwards/backwards from any zone.

## **Third-party control system**

Control via a third-party control system is supported using our latest and most advanced API to date. For an up-to-date list of systems that MHUB PRO 2.0 supports please visit the "Control Drivers" section of our support site: <http://support.hdanywhere.com>. Control varies depending on the control system being used but typically, switching is supported with other drivers able to offer more. Please consult a HDA Pro (page 17) to find out more.

## **MHUB-OS**

Any device with a web browser can control MHUB directly from MHUB-OS' dashboard. From here it is possible to control switching and ARC. MHUB-OS is also where all configuration for MHUB is done.

## **Master and Room remote controls (IR)**

MHUB supports the passing of IR commands from any display receiver location back to MHUB and vice versa, this is described on pages 14-15. Switching to audio sources is not supported nor is access to display ARC. In scenarios such as this, HDANYWHERE recommends using MHUB-OS' dashboard or uControl.



Help is only an email away: [support@hdanywhere.com](mailto:support@hdanywhere.com).

# Stacking: creating a Video & Audio (V&A) system

MHUB PRO 2.0 is a 'stackable' system meaning that it can be added to MHUB AUDIO (6x4) or any MHUB audio enabled device. When you create a system comprised of a video MHUB and an audio MHUB then we refer to this as a V&A system. System stacking is covered in more detail in audio enabled MHUB user guides. This section serves to provide a brief explanation of terminology and basic composition of a stacked system.

## Master & slave devices

Stacking works by taking one or more MHUB systems and combining them together so that it presents itself to the user as one larger system. A stacked system requires that a 'Master' MHUB is nominated as well as 'Slave' devices which the Master will control. All communication and the large majority of system configuration will be done on the Master system only. Once the MHUB systems are setup in stack mode then management of any of the slave devices becomes locked to the user.

## You can only create a stack with uControl

To create a stacked system you will need uControl. uControl will scan your network and will identify any MHUB that is present on it. If more than one MHUB is found then you will be presented with additional options: 1) to setup and connect to any MHUB system in standalone mode or 2) to combine one or more MHUB systems in to a stack. If you select option #2, then you will be asked to nominate your Master device first.

- If you are setting up a stack with a video MHUB and an audio MHUB (V&A) then the video MHUB will automatically be selected as the Master device.
- If you are setting up a stack with multiple MHUB AUDIO's then you will be given the option to choose which device is the Master.
- You can not create a stack with more than one video MHUB included.
- You are limited to a maximum of 3 Slave devices.
- You can reorder the Slaves in your stack to match how your systems are physically setup in your rack.

## TIP: Have a plan in place before you start

It is advisable to have a drawing or a plan in place before you start to connect your MHUB systems up. Outputs from MHUB can act as inputs for Slave MHUBs and both can be switched to any input/output combination. This can get very confusing! Detail everything and label your cables and interconnects to make troubleshooting easier.

## Modifying or deleting a stack after stack setup is complete

It is possible to modify any aspect of the stack setup from MHUB-OS and uControl. However, if you wish to add or remove a Slave device or would like to upgrade the Master MHUB then you will have to reset all systems in the stack back to factory settings and restart the setup Stack process.

# Wiring. Power

3.

**Up. First Boot.**

# Example wiring diagram

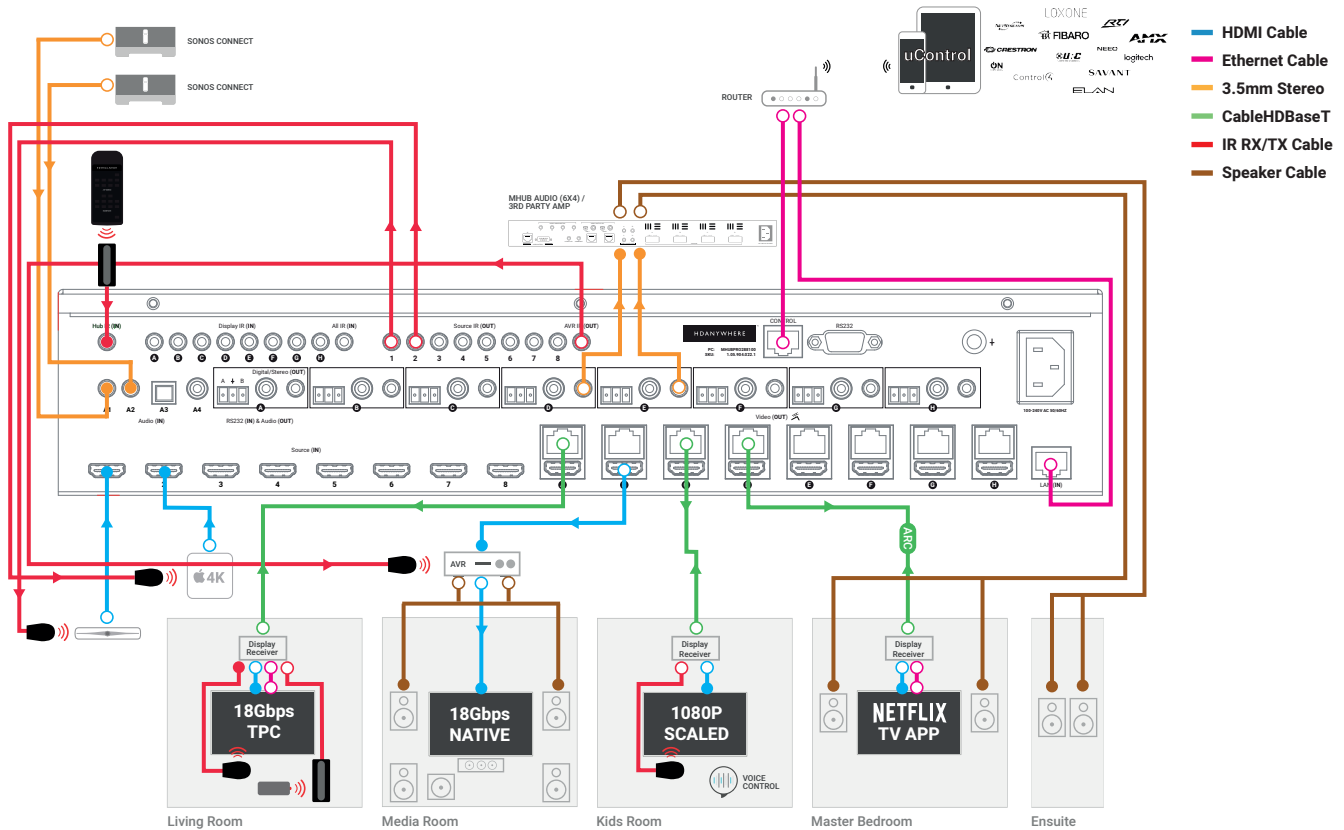

# Diagram explanation

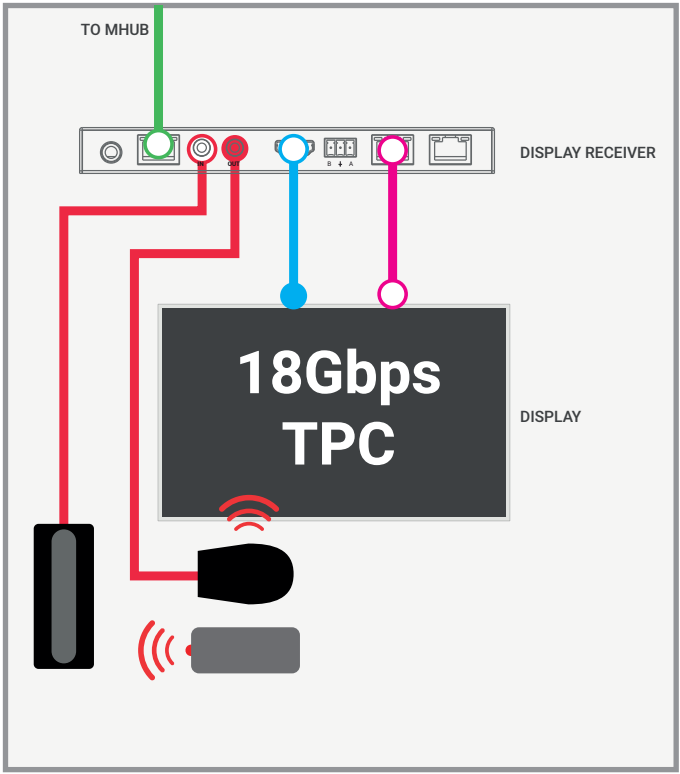

Living Room

In the diagram (“Example wiring diagram”) we have detailed a setup to show how the majority of MHUB’s feature-set could be connected and demonstrated together. All sources, displays, AVRs, amplifiers and MHUB systems are controlled by uControl and Amazon Alexa.

### Centrally located hardware, MHUB inputs, outputs and zones

There are four source inputs which are connected to this MHUB system. Two audio inputs from a SONOS Connect and two video sources; a set-top box and Apple TV 4K. There are additionally two centrally located audio distribution devices; an AVR, connected to the Media Room and MHUB AUDIO (6x4), driving speakers in the Master Bedroom and Ensuite locations. The video sources are controlled using MHUB’s IR ports and control over the AVR is enabled using the AVR IR port. Control over MHUB AUDIO is done over IP natively within uControl.

Video outputs A, B, C & D terminate in zones; Living Room, Media Room, Kids Room and Master Bedroom respectively.

Audio outputs D & E are being fed as inputs in to MHUB AUDIO (6x4) which has been configured in stack mode (V&A). The Ensuite is an audio only zone.

Network connectivity is fed in to MHUB via the LAN (IN) port directly from the router. This will provide every compatible display receiver with two additional LAN access ports at the display location. (MHUBPRO288100 only)

Control for MHUB comes from another network connection, this time made in to MHUB’s control port, marked “Control/IP”. Connecting this port is required to detect and configure MHUB using uControl.

### Living Room

The Living Room has both an IR RX and TX (see page 14) connected to its display receiver. This means that uControl can control the display and if the remote controls for Apple TV and the set-top box are in this room, then those IR commands can be

## Diagram explanation continued...

passed back to MHUB's IR TX ports to replicate the command providing control from the Living Room. The display in the living room is connected by HDBaseT and is using TPC to display a theoretical maximum 18Gbps bandwidth picture. Additionally, the display is able to receive 10/100 LAN connection via one of the two LAN ports on the display receiver to enable smart services or apps on the display.

### Media Room

The Media Room contains a multi-channel speaker setup (2.1/5.1/Atmos/DTS:X) powered by a centrally located AVR. Connectivity from MHUB to the AVR and to the display is entirely by HDMI to ensure an uncompressed/native picture is delivered to this zone for the very best picture and audio quality possible. Control for the AVR is provided by MHUB's AVR IR port which will allow uControl the ability to select inputs, adjust the volume or mute all sound in this location.

### Kids Room

The Kids Room contains a 1080p display. MHUB will automatically downscale any video source for this display so that a picture can be supported on it, even if all sources are outputting 4K. Control over the display is enabled using an IR TX and this display, and the content being watched on it, can be controlled from uControl or Amazon Alexa (TV on/off, change channel, execute sequence or adjust volume) which is also located in this room.

### Master Bedroom

This zone contains both a video and audio output from MHUB devices. In the example, there is no MHUB video source being fed to the display, instead, the display is using its own native smart service (Netflix) app. Smart services and apps have their network connectivity provided by one of the two 10/100 LAN ports on the display receiver.

The audio from Netflix can be extracted on demand using uControl and returned to MHUB using ARC. The audio is then routed to audio output D and then in to MHUB AUDIO (6x4) which is driving the speakers in the location.

### Ensuite

This is an audio only zone. Audio from the Sonos Connect devices can be routed to audio output E on MHUB and then routed as an input in to MHUB AUDIO (6x4) which then amplifies and drives speakers in the Ensuite.

### Embed audio sources on to any video output

Additionally, it is possible to take the audio from the SONOS Connect devices and route it to any location with a video output. For example, should you want to listen to music in the Media Room, it is possible to take the audio from SONOS and feed it via HDMI or HDBaseT in to the AVR to output on the speakers in that location.

#### Note:

MHUB has been designed so that it can be installed in several different ways. The purpose of the diagram is to illustrate a typical/example setup and assumes that you are already familiar with the basics of wiring and infrastructure. If you are unsure how you might install MHUB in to your property then contact [support@hdanywhere.com](mailto:support@hdanywhere.com) for further assistance.





# Power up

This section describes the power up process for MHUB PRO 2.0, operating in standalone mode (by itself). If you are creating a V&A/stack system then please consult the MHUB AUDIO (6x4) manual for detailed instructions.

**Avoid using uControl until MHUB has been connected to the local network and the system is powered on.**

- 1 Ensure that all devices are turned off.
- 2 Connect HDMI and audio sources to the input ports on MHUB. If any sources require IR control, ensure that IR is connected at this stage as well.
- 3 Connect each display receiver to MHUB using Cat 6/7 cable in to MHUB's video output ports.
- 4 Connect any HDMI video outputs such as AVRs or mirrored displays using HDMI cable to MHUB's video output ports.
- 5 Connect MHUB's audio output ports to speakers, AMP/AVRs or distribution hardware such as MHUB AUDIO (6x4).
- 6 Ensure that HDMI cables are fed from display receivers in to their respective displays and that any IR hardware is connected as well.
- 7 Connect an Ethernet cable between your router and the IP control port on your MHUB.
- 8 Connect an additional Ethernet cable between your router and the LAN (IN) port on your MHUB (MHUBPRO288100 only).
- 9 Plug in the supplied IEC power lead, MHUB will automatically power on and power will be fed to all display receivers. MHUB and all connected display receivers power indicators should be lit and solid.
- 10 Turn on each source device one after another followed by each display.
- 11 Ensure that displays are set to the correct HDMI input. Picture and sound from source devices will now be displayed on screen.
- 12 MHUB will have completed initial boot up (this can take up to 60 seconds after step #9). Ensure this period has passed before proceeding to the next step.
- 13 Install uControl on your iOS or Android device and run the application.
- 14 Complete setup on uControl (see "Setup on uControl").

# Setup v

4.

with uControl.

# Setup on uControl

Before starting setup on uControl, ensure that your MHUB is wired up correctly, is turned on and is connected to the same network as your phone or tablet. If it is not, then please refer to pages 25 and follow the steps there. You can not proceed with setup if you do not have uControl installed on your mobile device. uControl is available on iOS and Android Play stores and can be found by searching "uControl" - look for a black icon with "HDA" written inside it.

Completing setup in uControl will teach the MHUB what inputs are connected to it and where the outputs are located throughout your property (zones). Additionally, it will grant you access to MHUB-OS for advanced management of your MHUB and, should you wish, connect MHUB to HDANYWHERE's online services (HDA Cloud) to register your unit, extend your warranty, connect to the uControl service, enable voice control and remote monitoring or management.

## Start setup with uControl (Part 1)

1. Load up uControl. You will be presented with an intro screen which will automatically disappear or can be swiped away.
2. You will now see the home screen. This screen is only visible when no MHUB system is paired with uControl.
3. There are three options "Connect to MHUB", "Help" and an advanced management/tool option called "Manually Connect". Select "Connect to MHUB System".
4. uControl will now perform a scan of your network and will find all active MHUB systems.
5. If there are any problems detected in the scan then they will be displayed in uControl here. The messages are dependent on what is detected:

**Software Update Required:** uControl has detected that one or more MHUB's requires an update to proceed. Remedy: update all MHUB's in your network.

**Software Mismatch:** the software found on one or more MHUB systems do not match. Remedy: update all MHUB's in your network.

**MHUB's is still in Stack:** uControl has detected that one or more MHUB systems are still in stack mode. Remedy: reset the MHUB in question back to factory settings.

6. If there are no errors then uControl will present you with the following options:
  - 1) if a standalone MHUB is found then uControl will proceed to configure that system directly. (Jump to step 8).
  - 2) if multiple MHUB's are found then uControl will ask if you want to stack those systems (if supported) or connect to one of them individually.

7. If MHUB is being setup in Stack mode then you will be asked to nominate a Master and Slave device(s).

8. uControl will then connect to your system to start the configuration process.

9. You will now be redirected to MHUB-OS, the operating system on board MHUB, to complete the setup process (see next page).



**... From uControl, proceed to configure MHUB-OS' first boot process (Part 2)**

|   |  |
|---|--|
| 1. EULA & Privacy Policy                    | End User License Agreements and Privacy Policy statements. You can not proceed with setup if these are not agreed to first.  |
| 2. Name your MHUB                           | Provide a unique name for your MHUB so that you can identify it easily. In stack mode all detected MHUB devices will appear here.  |
| 3a. Define connections between MHUB systems | If your MHUB(s) are being setup in stacked mode then this is where you will define what outputs from your Master MHUB system are being routed to inputs on your Slave MHUB system(s).  |
| 3b. Split inputs                            | If you are using an audio splitter to split one or more audio sources to multiple MHUB systems then this is where this relationship is defined.  |
| 4. Name your source devices                 | Give each one of your source devices a unique name (eg "Sonos", "CD Player") so that you can identify and switch to easily. If you are setting your MHUB up in stack mode then any inputs assigned in steps 3a & 3b will become locked and unavailable to edit as their input is dynamic depending on the output of the master device. |
| 5. Create zones                             | A zone is a room or location in your property where outputs from MHUB terminate in (eg "Kitchen", "Living Room", "Bar").   |
| 6. Assign outputs to zones                  | A zone can contain up to 4 outputs in total. However, zones are limited to supporting only one video enabled MHUB output.  |
| 7. Confirm zones                            | An opportunity to review your changes.   |
| 8. Connect MHUB to HDA Cloud                | Register MHUB on HDA Cloud to access online services, to extend your warranty and to grant permission for remote monitoring and management to take place if your MHUB has been installed by a HDA Pro. The email address must belong to the owner of the MHUB device.  |
| 9. Complete setup                           | A final step before returning back to the main uControl interface.   |



6.

**MHUB-OS.**

# Accessing MHUB-OS

MHUB-OS is the operating system on board all MHUB systems and must be configured first before you can use it (see page 28-29). MHUB-OS manages the operation of your MHUB, the connection between MHUB and your control method (see page 18) and the connection to online services like HDA Cloud and Amazon Alexa. MHUB-OS is not typically a feature that you would access daily but something where configuration and user settings are applied so that MHUB operates in the manner you like.

## Accessing MHUB-OS

1. Ensure that you have completed the first boot process and that MHUB is on and connected to your network.
2. Load uControl: it will connect with MHUB and you will be taken to the main control interface.
3. Tap on the Menu icon represented by three horizontal lines. A menu will appear from the left side of your screen.
4. Tap on the Cog icon in the bottom left corner to be navigated to the main Settings menu.
5. Select option: "Access MHUB".

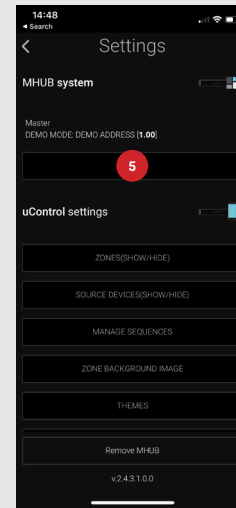
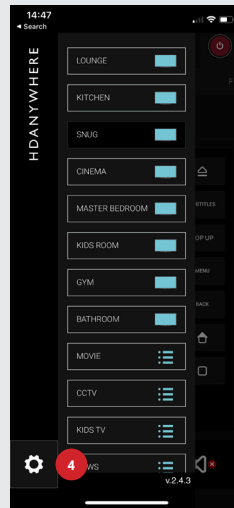
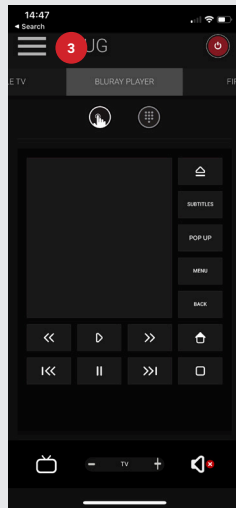



# MHUB-OS pages described

Configuration options for MHUB within MHUB-OS are detailed below.

|                        |   |
|------------------------|---|
| Homepage / Dashboard   | The homepage for MHUB-OS. Control input switching, toggling ARC mode and audio embedding on video outputs from this page. Controls to put MHUB in to standby mode is also available here.   |
| Account Management     | <p>Create a HDA Cloud account and register MHUB to extend warranty by 1 year. Registering MHUB on HDA Cloud will allow MHUB to connect to other online services such as Amazon Alexa and will grant permissions to have MHUB remotely managed by your installer (HDA Pro) if you have one. Having this account in place will also allow HDANYWHERE to access technical data from your system to provide better support should you experience any difficulties.</p> <p>HDA Pro pairing:<br/>If you are a professional installer and have an approved HDA Pro account then add your details to the HDA Pro area <b>in addition to the HDA Cloud account details</b> to setup MHUB for remote management. Ensure that you have permission from the MHUB owner and that their HDA Cloud account is in place otherwise pairing/remote monitoring will not be possible.</p> |
| MHUB Setup             | This page describes basic configuration settings needed to operate MHUB on a daily basis. It contains a list of MHUB-OS software, firmware and identifying information. From here it is possible to name source devices, create and manage zones, manage output assignment, set time zone, set security PIN and apply a custom LCD message.   |
| Network Settings       | Manage the network settings for MHUB such as DHCP.  |
| uControl               | Download or delete uControl Packs from HDA Cloud and assign them to input or display receiver IR ports to enable remote control of sources, displays and AVRs. An active HDA Cloud account is required to access this service. Additionally, browse and test CEC commands to see if your display is supported.  |
| Sequences & Scheduling | A Sequence is a string of individual commands such as (switch to input 1, change channel to 101, mute output A & D) which can be triggered by a single button press or Alexa voice command. Create and test Sequences from this page. Additionally, it is possible to schedule a Sequence so that it executes automatically at a set time or date.  |
| Voice Control          | Options to configure voice control for supported devices can be found here.   |
| AV Settings            | Manage EDID, video scaling modes and audio output settings from this page.  |
| Control Drivers        | Links to HDANYWHERE Support ( <a href="http://support.hdanywhere.com">http://support.hdanywhere.com</a> ) for access to control drivers for MHUB.   |



7.

**uControl it.**

## uControl interface

uControl is MHUB's native method of control which can be used to control all sources, AVRs, displays and other MHUB devices from anywhere in your property.

The following pages describe the main interface areas, their function and how to use them.

1 Tapping this button reveals the zone selector and allows access to the settings menu (see #10-12).

2 This label indicates the zone that you are controlling. All control commands are targeted in this area.

3 Zone power control: this button reveals a sub menu containing all devices available which can be turned on or off. Power buttons can be displayed in two colours describing how you interact with the button: Red) indicating the device power control can be toggled, a tap to turn on and a tap to turn off. Blue) meaning that the power control requires an explicit interaction to turn on or off. Tap to turn off and press and hold for 2 seconds to turn on.

4 Control selector bar. This bar includes all sources that can be controlled in your system. All devices are listed in this bar and navigating between devices can be done by swiping left or right horizontally. Devices can be removed or added back by accessing uControl settings.

5 Control group icon: on smaller devices controls are grouped together for quicker access. If your device has its controls grouped then the icons will appear here, examples are numeric keypads, or playhead controls which are typically grouped together.

6 Control interface. This area is where your control interface is displayed. The control interface will change dynamically depending on the device that you have selected from the control selector bar.

7 Gesture control area will appear in the control interface as a large square or rectangle. This area supports nine control types familiar to all mobile device users. Swipe up, down, left or right to replicate the same command on your device. Tapping acts as an Enter command. Additionally, if supported, then two fingers down will pause and two fingers up will resume. Drawing a chevron to the right will skip forward and a chevron to the left will take you back.

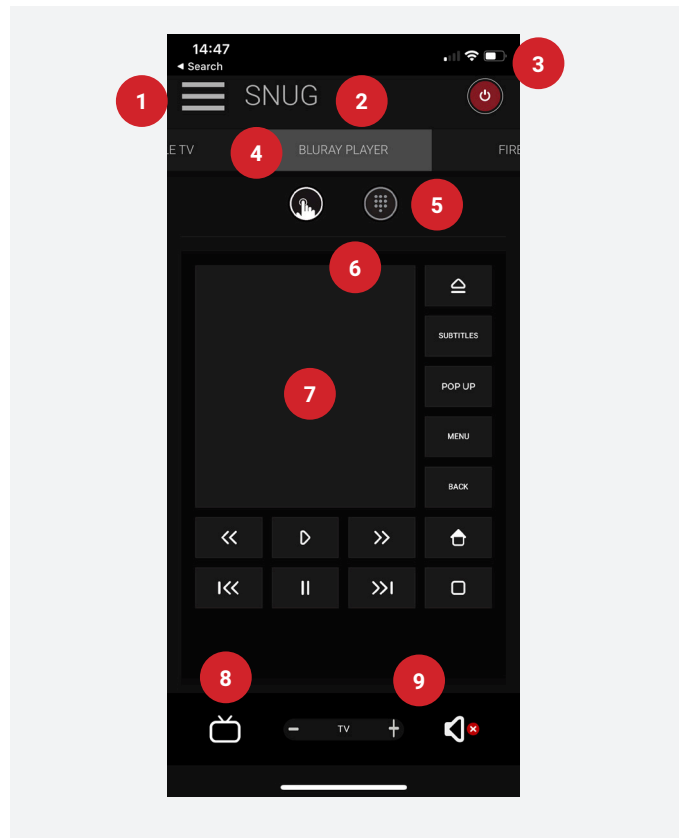

Audio selector icon. Tapping this icon will cycle through the different audio devices that are available in that zone.

1. Display audio (TV & speaker icon):

Provides volume/mute control for the display. Pressing and holding the TV icon will reveal ARC options if supported and any audio inputs connected to the MHUB.

2. AVR audio (AVR icon):

8 If the zone contains an AVR then volume/mute controls will be presented. When selected, all volume commands will be directed to the AVR instead of the display.

3. MHUB AUDIO (MHUB AUDIO icon):

A third tap will enable MHUB AUDIO volume control of speakers in that zone if MHUB PRO 2.0 has been configured as a V&A/stack. In this mode, volume buttons are replaced with an audio slider and an additional label is displayed to inform the user what audio is being routed to the speakers. Pressing and holding this icon will reveal a source selector menu allowing you to switch to audio inputs directly connected to MHUB AUDIO.

9 Volume control: increase or decrease volume by using a slider (MHUB AUDIO only) or tapping the "+" or "-" buttons. Tapping the mute icon will reduce the volume to 0 or put the device in a mute state. Volume commands are targeted depending on what audio device is active as per point #8.

10 Tap to access uControl and MHUB-OS settings for app and MHUB configuration options.

11 Change zones by selecting the zone you wish to control here. If a blue display icon appears then this means that there is display control in that zone. Zones can be reordered or removed by pressing and holding on the zone label and then clicking "Done" which appears near location #10.

12 Execute Sequence. If you have created a Sequence in MHUB-OS then you can make it visible from uControl's setting page. Tapping the Sequence button will execute that Sequence anywhere in the property.

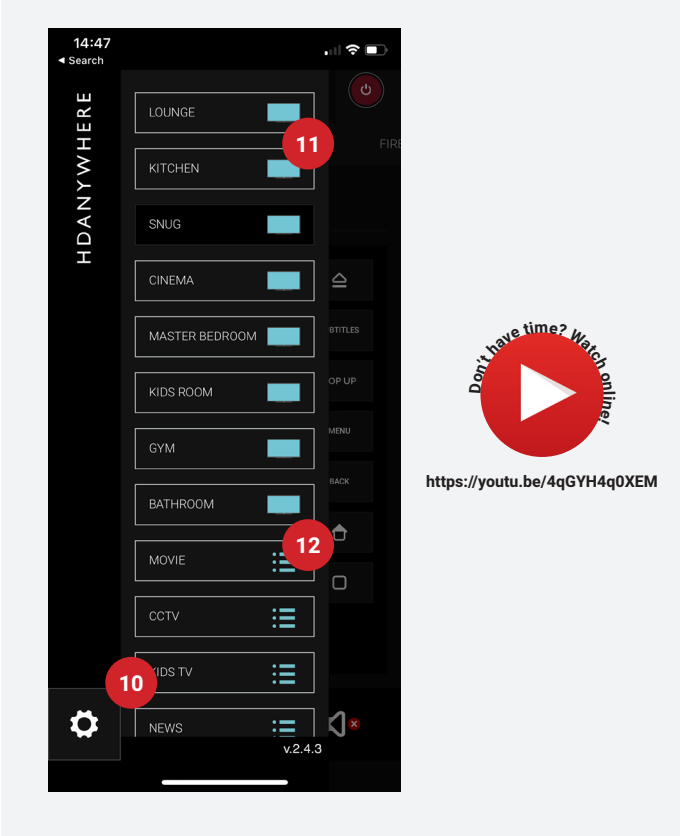



8.

**The Legal Bit.**

# Important information

## **Terms & Policies, including General Data Protection Regulation (GDPR) and other Data Protection Laws.**

During the setup of MHUB, the HDA Pro (Installer) and End-User are required to agree to a set of terms, conditions, rules, policies and license agreements, including the HDANYWHERE Privacy Policy. These terms, notices and policies are, collectively, the "Agreements". By installing or using MHUB, you agree to be bound by the Agreements.

## **EU Conformity**

Hereby, HDANYWHERE declares that this HDMI connectivity device is in compliance with the essential requirements and other relevant provisions of the following Directives: 2006/95/EC (LVD Directive); 2004/108/EC (EMC Directive); 1999/5/EC (R&TTE Directive). The full text of the EU declaration of conformity is available in the compliance section at [HDANYWHERE.com/legals](https://hdanywhere.com/legals)

## **Recycling your device properly**

In some areas, the disposal of certain electronic devices is regulated. Make sure you dispose of or recycle your device in accordance with your local laws and regulations.





# HDANYWHERE Limited Product (3 or 4 Year) Guarantee

## WHO WE ARE

1. We are HD CONNECTIVITY LTD trading as HDANYWHERE ("HDA"), a limited company registered under number 06046737 in England and Wales with its registered offices at The Haysfield, Malvern, WR14 1GF, United Kingdom.

## OUR GUARANTEE TO YOU

2. We, HDANYWHERE warrant to you, the end user [MG1] of the HDA hardware (the "Products") that on the date of delivery of the Products to you, and for a period of 3 years from that date of delivery, the Products shall:

- match any description that has been provided to you;
  - be free from any significant defects in their design, the materials used to make them, and the way they are made;
  - be of satisfactory quality (within the meaning of the Consumer Rights Act 2015); and
  - be fit for any purpose held out by us.
- This 3 year period, or, if the period has been extending to 4 years in accordance with paragraph 3, will be the "Guarantee Period". We offer this guarantee to all our customers who are resident and have an address in Great Britain and Northern Ireland. [MG2]

## EXTENDING YOUR GUARANTEE

3. On registering your Products with the HDA Cloud, the guarantee offered in paragraph 2 by us will automatically extend for a period of one year, provided that your registration takes place within 30 days from the date of delivery. The one year guarantee extension starts automatically from the date that the original 3 year guarantee ends.

## HOW TO CLAIM ON YOUR GUARANTEE AND YOUR REMEDIES

4. Subject to paragraphs 5 and 6 of this guarantee, Your sole remedies under Our guarantee to You are as follows: (i) Up to 30 days: we will repair or replace your Products or provide you with a full refund of the price of the defective Products at your option.

(ii) Up to 6 Months: we will repair or replace your Products. If we are unable to repair or replace your Products we will provide you with a full refund of the price of the defective Products.

(iii) Up to 3 (4) Years: we will repair or replace your Products. If we are unable to repair or replace your Products we will provide you with a partial refund of the price of the defective Products based upon the devaluation of the Products since the time of purchase.

5. In order to claim under the guarantee given to you in paragraph 2 you will need to:

- give us notice in writing of your intention to claim under the guarantee during the Guarantee Period, and do so within a reasonable time after finding that some or all of the Products do not comply with the guarantee set out in paragraph 2;
- show that the Products that you claim are defective, have been examined by a HDA Pro or other authorised suitably qualified installer, and that they have [MG3] confirmed in writing that the suspected defect in the Products stems solely from a fault in the HDA hardware;
- give us a reasonable opportunity to examine the Products in question;
- provide us with an order number and a dated sales or delivery receipt from an HDA Distributor, HDA Pro or other authorised dealer, reseller or installer of the Products.
- obtain from us in advance of returning the Products a return merchandise authorisation and/or case number [MG4]; and
- (if asked to do so by us) return such Products to our place of business at our cost.

## CIRCUMSTANCES WHERE YOUR GUARANTEE DOESN'T APPLY

6. We shall not be liable for the Products' failure to comply with the guarantee set out in paragraph 2 in any of the following events:

- If you make any further use of the Products after giving us notice of an issue in accordance with paragraph 5;
- the defect arises because you failed to follow our oral or written instructions as to the storage, installation [MG5], use and maintenance of the Products;

(c) the defect arises as a result of your use of the Products with any other software or hardware that is not compatible with the Products;

(d) the products are used by you for any commercial purpose, including rental or demonstrative purposes;

(e) you alter or repair the Products without the written consent of HDA;

(f) the defect arises as a result of an act of god, fair wear and tear, or your misuse, abuse, unreasonable use, wilful damage, negligence, or abnormal storage of the Products or by any other causes unrelated to defective hardware or manufacturing;

(g) where the serial number has been altered, defaced or removed;

(h) where the warranty seal on the system has been altered, defaced or removed; or

(i) where the Products differ from their description as a result of changes made to ensure they comply with applicable statutory or regulatory requirements.

## TRANSFERRING YOUR GUARANTEE TO SOMEONE ELSE

7. [HDA will not accept any liability under such guarantee unless you are the original customer or can produce a letter or chain of letters from the original customer and subsequent customers (where appropriate) transferring the benefit of the guarantee to you.]

## PRODUCTS THAT ARE NOT COVERED BY THIS GUARANTEE

8. This guarantee does not cover products sold and clearly marked "as is", "B-grade", or with faults. This guarantee does not apply to any system software that is preinstalled in the HDA hardware, or is subsequently provided via update or upgrade releases. Any and all HDA software is licensed to you under the terms of a separate end user licence agreement found here: [EULA Link]

## HOW THIS GUARANTEE WORKS WITH OUR EULA

9. We may void this guarantee if we reasonably believe that the HDA system has been used in a manner that violates terms of our separate End User Licence Agreement (EULA) for the HDA software. You assume all-risk and liabilities associated with the use of third party products in conjunction with the Products.

## YOUR STATUTORY RIGHTS

10. This guarantee is in addition to your statutory rights (including under the Consumer Rights Act) which are not affected by this guarantee

## GENERAL TERMS OF THIS GUARANTEE

11. Except as provided in this guarantee, we shall have no liability to you in respect of the Products' failure to comply with the guarantee set out in paragraph 2.

12. We reserve the right to amend or withdraw this guarantee at any time although for the avoidance of doubt any guarantees that are in existence at such a time will be honoured.

13. These Conditions shall apply to any repaired or replacement Product supplied by us.

## GUARANTEE CONTACT INFORMATION

To contact (support@hdanywhere.com) or call HDANYWHERE Technical Support (call charges will depend on your telephone provider. Please check with your operator for exact charges).

The team is available 9am - 5pm weekdays.

To help us handle your query promptly, please have your invoice number and model SKU and serial ready.

HDANYWHERE™

**Let us know what you think.**

We would love to hear how we could further improve our products and services.  
If we can make something better, please let us know!

[support@hdanywhere.com](mailto:support@hdanywhere.com)

Copyright © HDANYWHERE.

HDANYWHERE™ is a trading name of HD Connectivity Ltd.

Registered in England & Wales 06046737 VAT 913222367

HDANYWHERE assumes no responsibility for any inaccuracies that may be contained in this document. In no event will HDANYWHERE be liable for direct, indirect, special, incidental, or consequential damages resulting from any defect or omission in this document, even if advised of the possibility of such damages.